

AMERICAN DELUXE STRATOCASTER® 0101220/1222, RW, MN, LH

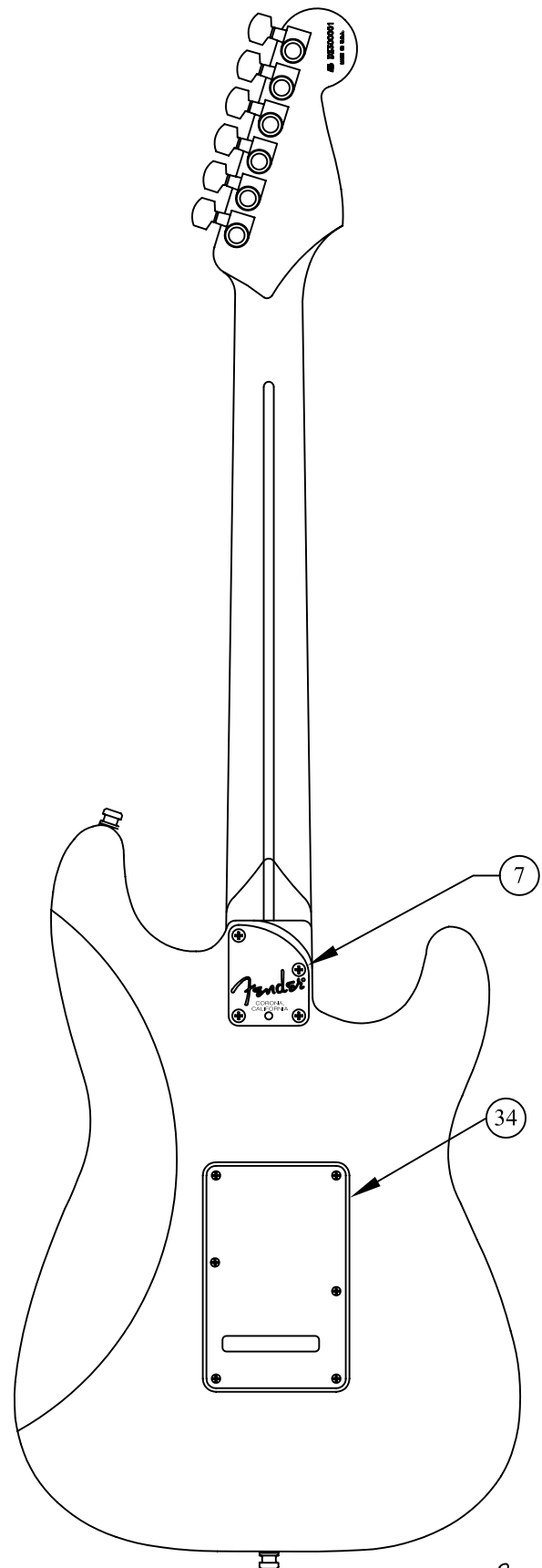

*Fender*®

WIRING DIAGRAM

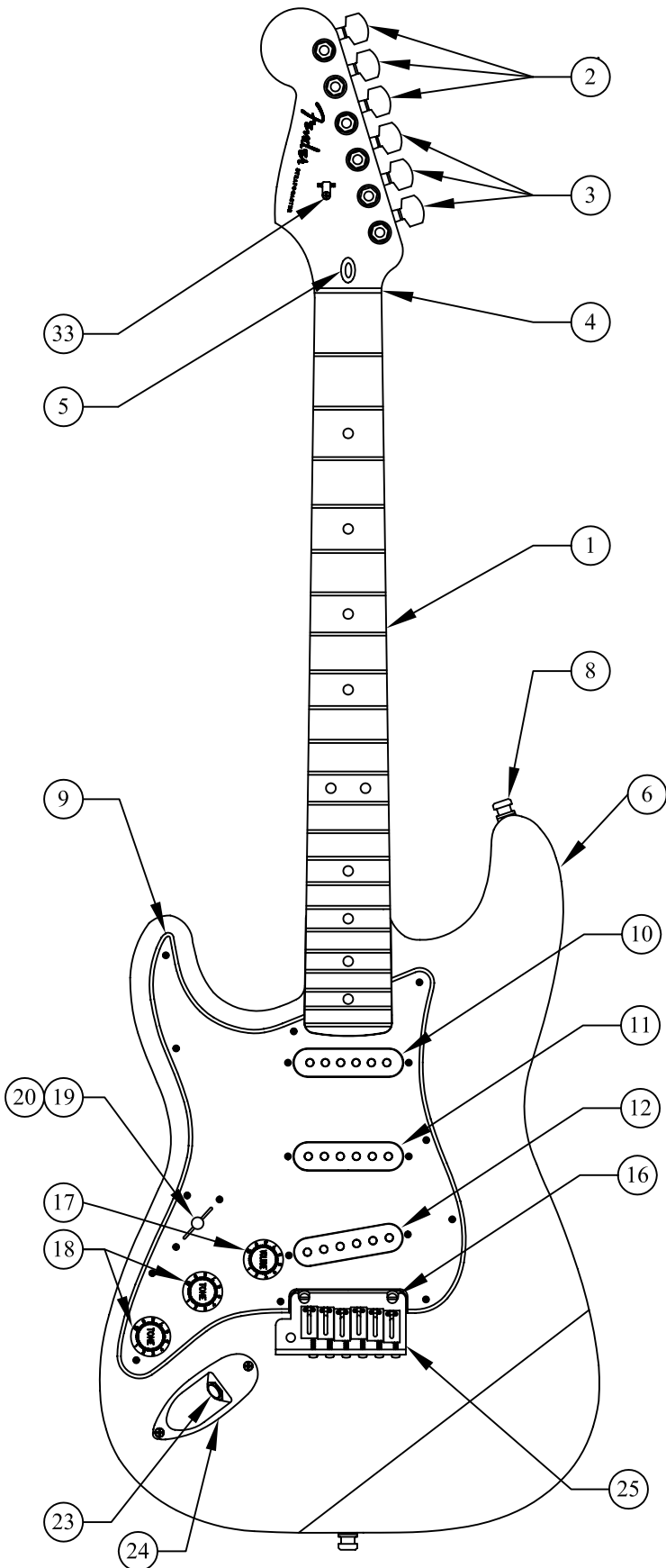
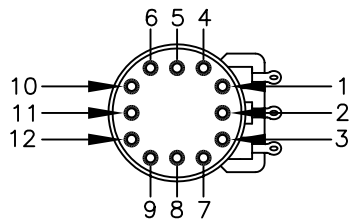
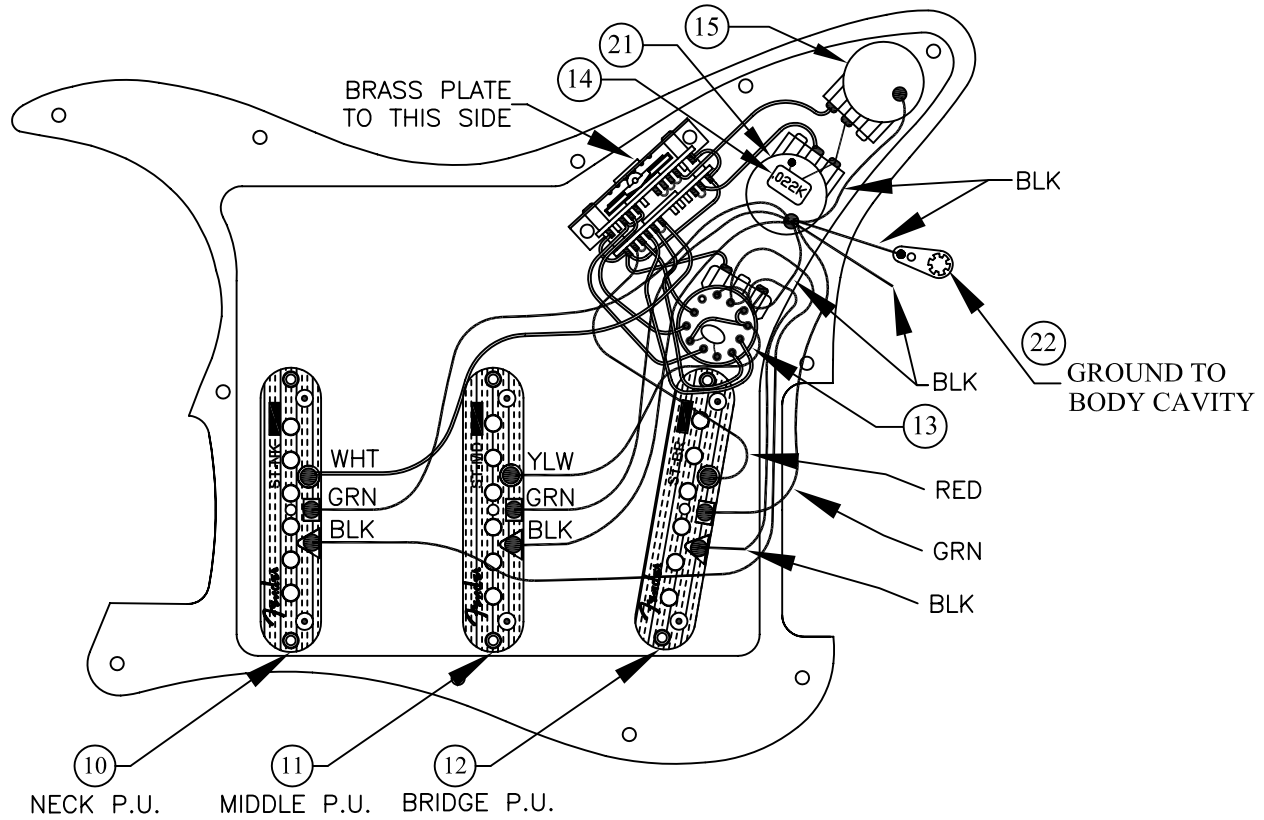

S-1 SWITCH TERMINAL NUMBERS

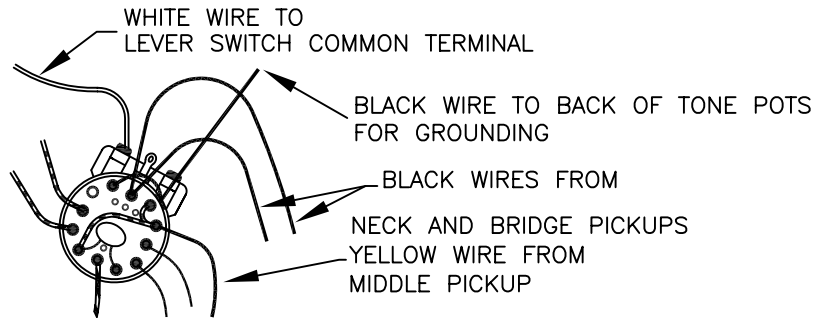

S-1 SWITCH WIRING DETAIL

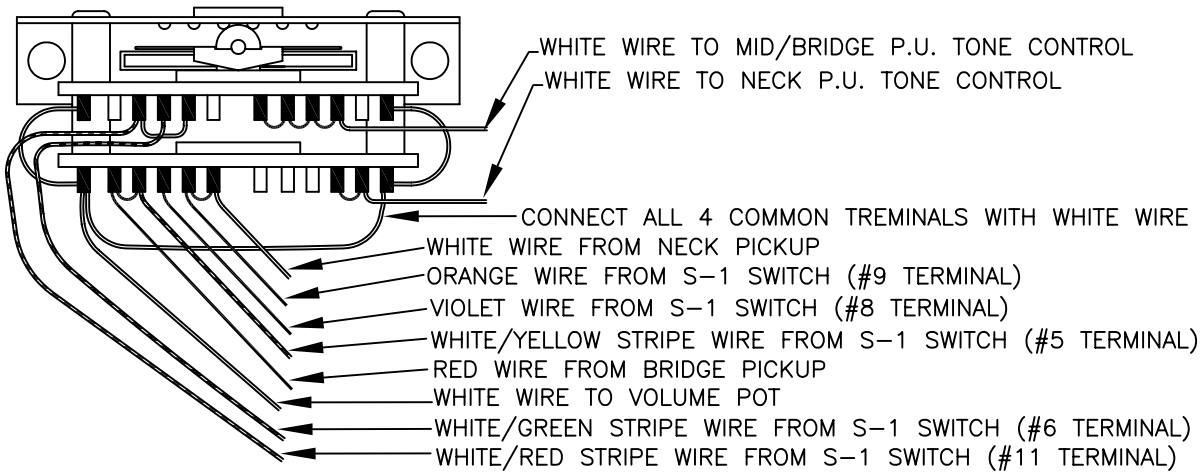

LEVER SWITCH WIRING DETAIL



# AMERICAN DELUXE STRATOCASTER® 0101220/1222, RW, MN, LH

## BODY, PICKGUARD, PICKUP, BACKPLATE & KNOB COMBINATION CHART

BODY		PICKGUARD		PICKUP			BACKPLATE		VOLUME		TONE	SEL SW
P/N	Color	P/N	Color	P/N	REF.#	Color	P/N	Color	Knob	Cap	Knob	Knob
0059206500	3 Color Sunburst	0055320000	Mint Green	063963-030	10	Aged White	0055322000	Mint Green	0059267-030 Aged White	0059266-030 Aged White	0056144000 Aged White	0053765000 Aged White
				063964-030	11	Aged White						
				063965-030	12	Aged White						
0059208564	Montego Black	0063541000	Metallic Gold	063963-020	10	Black	0063545000	Metallic Gold	0059267-020 Black	0059266-020 Black	0056146000 Black	0013267000 Black
				063964-020	11	Black						
				063965-020	12	Black						
0059208591	Chrome Silver	0063966000	Black Pearl	063963-020	10	Black	0063969000	Black Pearl	0059267-020 Black	0059266-020 Black	0056146000 Black	0013267000 Black
				063964-020	11	Black						
				063965-020	12	Black						

REF.#	P/N	DESCRIPTION	REF.#	P/N	DESCRIPTION
1	0055304000	Neck, Am Dlx Stratocaster®, RW, LH	16	0028957000	Pivot Screw
	0055305000	Neck, Am Dlx Stratocaster®, MW, LH		0028958000	Insert
2	0055306000	Tuning Key, (1,2,3) Ultra Pol Chr, LH	17	See Chart	Knob & Cap, Volume
	0058815000	Washer Schalr	18	See Chart	Knob, Tone
	0058820000	Bushing Schalr	19	See Chart	Knob, Selector Switch
3	0055307000	Tuning Key, (4,5,6) Ultra Pol Chr, LH	20	0050610000	Switch 5-Position, 4-Pole
	0058815000	Washer Schalr		0021417000	Mounting Screw
	0058820000	Bushing Schalr	21	0024832000	Capacitor, .022uF
4	0083675000	Bone Nut	22	0012869000	Solder Lug
5	0023811000	Truss Rod Adjusting Wrench		0015116000	Mounting Screw
6	See Chart	Body Stratocaster®	23	0021956000	Output Jack
7	0059210000	Neck Mounting Plate		0016436000	Lock Washer
	0021424000	Mounting Screw		0016352000	Mounting Hex Nut
	0031571000	Tilt Adjustment Screw	24	0010280090	Jack Ferrule
	0023811000	Tilt Adjusting Wrench		0021407000	Mounting Screw
8	0021453000	Strap Button	25	0055318000	Bridge Assembly
	0021422000	Mounting Screw		0055319000	Tremolo Arm
	0019056000	Felt Washer, Black		0010272100	Tremolo Claw
	0020491000	Felt Washer, White		0018671000	Tremolo Spring
9	See Chart	Pickguard		0015636000	Mounting Screw
	0021407000	Mounting Screw		0055317000	Bridge Plate
10	See Chart	Pickup, Neck		0055316000	Bridge Section, (6)
	0063396000	Mounting Screw		0017031000	Intonation Screw, (6)
	0063398000	Mounting Spring		0019395000	Intonation Spring, (5&6)
11	See Chart	Pickup, Middle		0019394000	Intonation Spring, (1-4)
	0063396000	Mounting Screw		0026779000	Height Adjustment Screw, (1&6)
	0063398000	Mounting Spring		0026780000	Height Adjustment Screw, (2-5)
12	See Chart	Pickup, Bridge		0055315000	Bridge Block
	0063396000	Mounting Screw		0036615000	Set Screw
	0063398000	Mounting Spring	33	0021537000	String Retainer
13	0063987000	Switch Control Assembly, Volume		0021405000	Mounting Screw
	0016352000	Mounting Nut	34	See Chart	Back Plate AM Series Stratocaster®
	0022384000	Lock Washer		0021407000	Mounting Screw
14	0063892000	Control 250K			
	0016352000	Mounting Nut			
	0022384000	Lock Washer			
15	0063892000	Control 250K			
	0016352000	Mounting Nut			
	0022384000	Lock Washer			



SWITCH & CONTROL FUNCTION

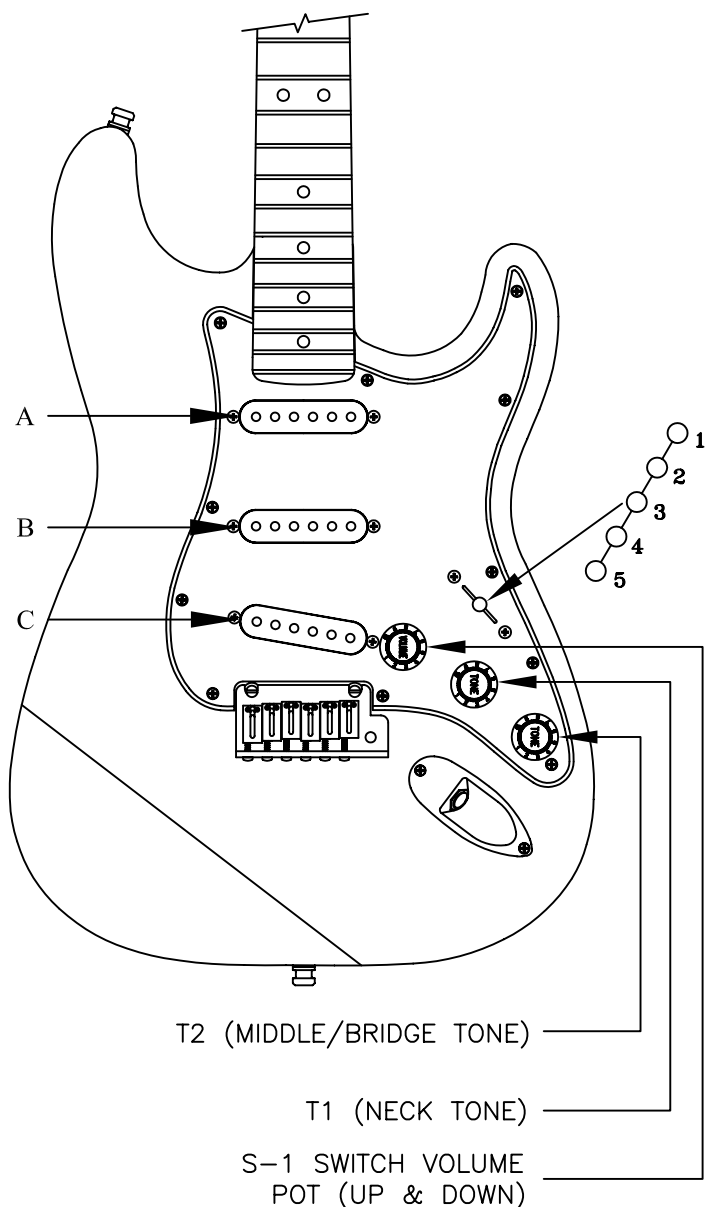

MV = MASTER VOLUME  
 T1 = NECK TONE  
 T2 = MID/BRIDGE TONE  
 + = SERIES CONNECTION  
 / = PARALLEL CONNECTION  
 SC = SPECIALS CAPACITOR

5 WAY SW POSITIONS, S-1 SWITCH UP

1	2	3	4	5	POSITION
MV T1	MV T1+T2	MV T2	MV T2	MV T2	CONTROL
					← NECK (A)
					← MIDDLE (B)
					← BRIDGE (C)
	A/B		B/C		CONNECTION

5 WAY SW POSITIONS, S-1 SWITCH DOWN

1	2	3	4	5	POSITION
MV T1	MV T1+T2	MV T2	MV T2	MV T2	CONTROL
					← NECK (A)
					← MIDDLE (B)
					← BRIDGE (C)
A+B	(A/SC) + B	(A/C) + B	B + (C/SC)	B+C	CONNECTION

	PICKUP IS ON
	PICKUP IS OFF
<i>A</i>	PICKUP (NECK)
<i>B</i>	PICKUP (MIDDLE)
<i>C</i>	PICKUP (BRIDGE)

